

# CYRUS

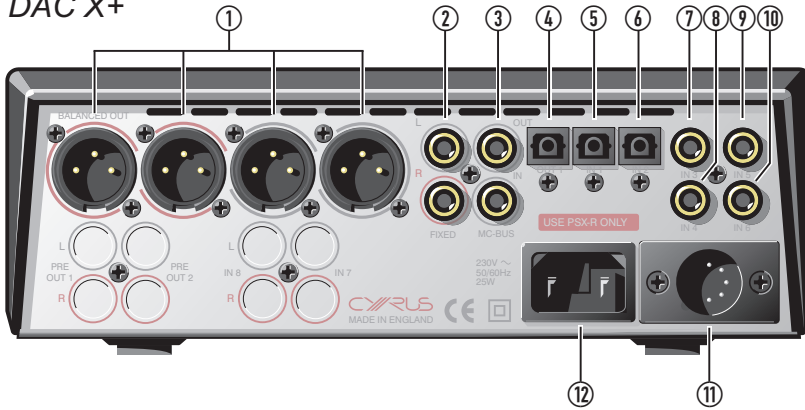

### DAC X+



### DAC XP+

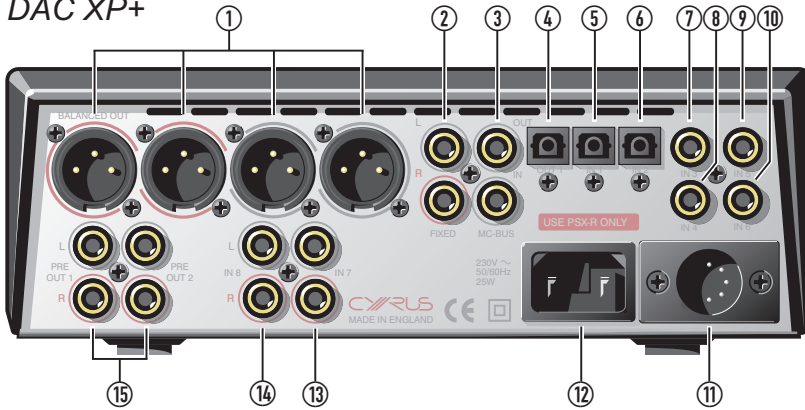

Fig 1

### MC-BUS

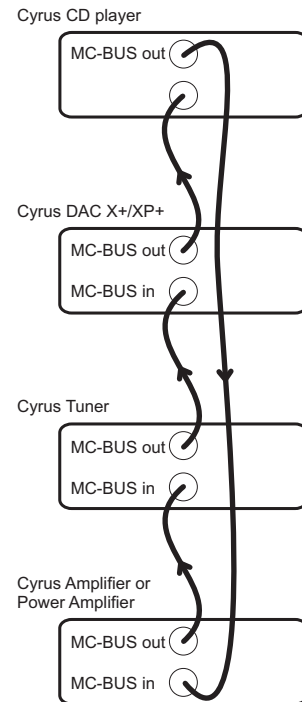
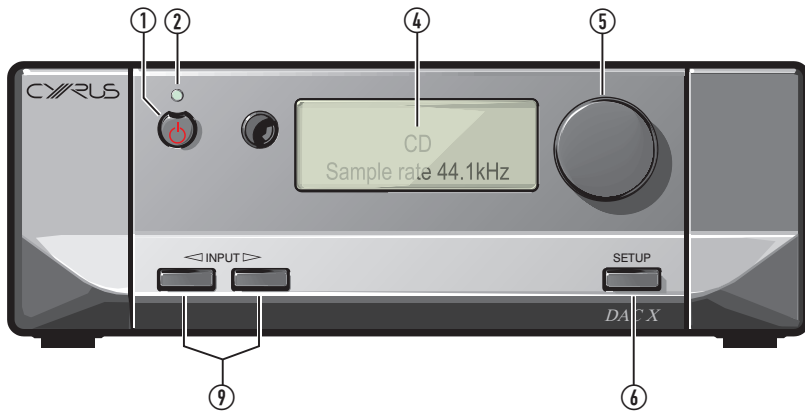

Fig 3

### DAC X+



### DAC XP+

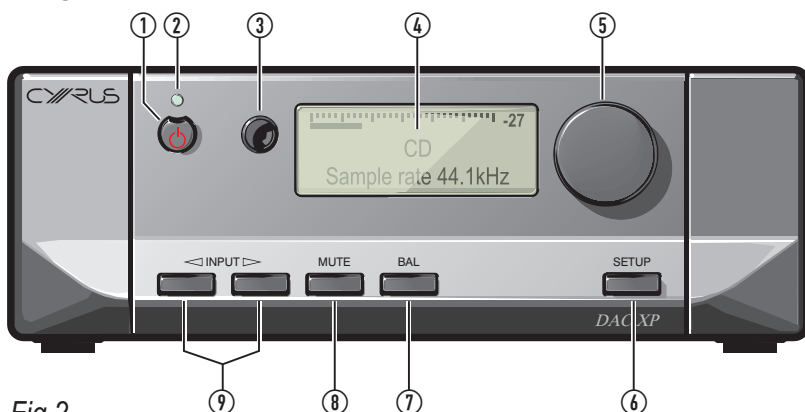

Fig 2

Fig 4a

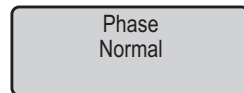

Fig 4b

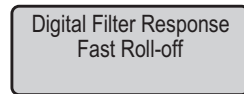

Fig 4c



Fig 4d



Fig 4e

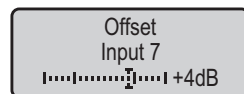

Fig 4

**IMPORTANT! Read before operating this equipment!**

**CAUTION:** The exclamation mark is to draw your attention to important instructions and safety procedures in this manual.



**ATTENTION:** The lightning flash warns you of the risk of electrical shock presented by components inside this product. Unauthorised personnel must not open this unit.



**WARNING:** To reduce the risk of electrical shock do not remove any unit covers or panels. There are no user serviceable parts in this product.

**WARNING:** To reduce the risk of electric shock, do not expose this equipment to rain or moisture.

**HEED WARNINGS:** All warnings on the product and in the operating instructions should be adhered to.

**READ ALL THE INSTRUCTIONS:** All the safety and operating instructions should be read before the product is operated.

**RETAIN INSTRUCTIONS:** The safety and operating instructions should be retained for future reference.

**FOLLOW INSTRUCTIONS:** All operating and use instructions should be followed.

**CLEANING:** Unplug this product from the mains before cleaning. Do not use liquid or aerosol cleaners. Use a damp cloth for cleaning.

**WATER AND MOISTURE:** Do not use this product near water - for example, near a bath tub, wash bowl, kitchen sink, or laundry tub, in a wet basement; or near a swimming pool and the like. The product must not be exposed to dripping or splashing and no objects filled with liquids, such as vases, shall be placed on the product.

**HEAT:** The product should be situated away from heat sources such as radiators, stoves, or any other products (including amplifiers) that produce heat.

**VENTILATION:** Slots and openings in the cabinet are provided for ventilation, to ensure reliable operation of the product and to protect it from overheating and these openings must not be blocked or covered. The openings should never be blocked by placing the product on a bed, sofa, rug or similar surface. This product should not be placed in a built-in installation such as a bookcase or rack unless proper ventilation is provided or the manufacturer's instructions have been adhered to.

**OBJECT OR LIQUID ENTRY:** Never push objects of any kind into this product through openings as they may touch dangerous voltage points or short-out parts that could result in a fire or electric shock.

**ACCESSORIES:** Do not place this product on an unstable cart, stand, tripod, bracket, or table. The product may fall, causing serious injury to a child or adult, and serious damage to the product. Use only with a cart, stand, tripod, bracket or table recommended by the manufacturer, or sold with the product. Any mounting of the product should follow the manufacturer's instructions, and should use a mounting accessory recommended by the manufacturer.

**ATTACHMENTS:** Do not use attachments not recommended by the product manufacturer as they may cause hazards.

**MOVING THE PRODUCT:** A product and cart combination should be moved with care. Sudden stops, excessive force, and uneven surfaces may cause the product and cart to overturn.



**POWER SOURCES:** This product should be operated only from the type of power source indicated on the marking label. If you are not sure of the type of power supply to your home, consult your product dealer or local power company. For products intended to operate from battery power, or other sources, refer to the operating instructions.

**OVERLOADING:** Never overload wall outlets, extension cords, or integral convenience receptacles. This can result in an increased risk of fire or electric shock.

**POWER CORD PROTECTION:** Power supply cords should be routed so that they are not likely to be walked on or pinched by items placed upon or against them, paying particular attention to cords at plugs, convenience receptacles, and the point where they exit from the product.

**NAKED FLAMES:** No naked flame sources, such as candles, must be placed on this product. Batteries (battery pack or batteries installed) shall not be exposed to excessive heat such as sunshine, fire or the like.

**LIGHTNING:** For added protection for this product during a lightning storm, or when it is left unattended or unused for long periods of time, unplug it from the wall outlet and disconnect the antenna or cable system. This will prevent damage to the product due to lightning and power-line surges.

**BATTERIES:** Warning : Batteries shall not be exposed to excessive heat such as sunshine, fire or the like.

**CAUTION! POLARISED CONNECTOR (CANADA and USA):**

To prevent electrical shock, match wide blade of plug to wide slot, fully insert.

Do not alter or remove this plug if it does not fit your mains power socket. Have a suitable socket installed by a competent electrician.

**POWER SUPPLY:**

The moulded IEC connector of the AC cord supplied plugs into the power inlet @ on the rear of the unit.

The mains supply requirement for your *Cyrus* unit is marked on a label on the rear panel. Before connecting, check that this voltage is the same as your mains supply.

230V Products:	Voltage Range	220V-240V
115V Products:	Voltage Range	110V-120V

If you move to an area with a different mains voltage, contact your local *Cyrus* distributor to have your product converted.

There are no user replaceable fuses in this unit.

**SERVICING:**

Do not attempt to service this product yourself as opening or removing covers may expose you to dangerous voltage or other hazards. Refer all servicing to qualified service personnel.

**CONDITIONS REQUIRING SERVICE:** Unplug this product from the wall outlet and refer servicing to qualified service personnel when:

- When the power supply cord or plug is damaged.
- If liquid has been spilled, or objects have fallen into the product.
- If the product has been exposed to rain or water.
- If the product has been dropped or damaged in any way.
- If the product does not operate normally by following the operating instructions. (Adjust only those controls that are covered by the operating instructions. Improper adjustment of other controls may result in damage requiring extensive work by a qualified technician to restore the product to its normal operation).
- When the product exhibits a distinct change in performance.

**REPLACEMENT PARTS:** When replacement parts are required, be sure the service technician has used replacements specified by the manufacturer or have the same characteristics as the original part. Unauthorised substitutions may result in fire, electric shock, or other hazards.

**SAFETY CHECK:** Upon completion of any service or repairs to this product, ask the service technician to perform safety checks to determine that the product is in proper operating condition.

**PRODUCT SERVICE CENTRES**

For product service or technical advice, contact only authorised *Cyrus* service centres. Contact details for *Cyrus* distributors may be found on the *Cyrus* website at [www.cyrusaudio.com](http://www.cyrusaudio.com).

## Welcome to the world of *Cyrus!*

Congratulations on your choice of *Cyrus* Audio-Visual products. Our state-of-the-art design technology and outstanding quality of manufacture has won countless awards around the world. We are confident that you will derive great pleasure from owning a product from one of the most recognised and respected manufacturers of hi-fi equipment.

Now is a good time to register your new *Cyrus* product. Registration takes only a few minutes, brings the added benefit of a full two year factory warranty and adds you to our mailing list for future product updates and upgrades. To register, visit [www.cyrusaudio.com](http://www.cyrusaudio.com) and click the 'Login/Register' link.

Please read these instructions carefully before commencing installation. They provide full guidance to help you install your *Cyrus* DAC safely and correctly.

## Preparations for Installation

Before installing your DAC check that the following items are included in the accessory box.

- Power Cable
- 2 MC-BUS phono cables
- Remote Control Handset (*DAC XP+ only*)
- 2 AAA Batteries (*DAC XP+ only*)

After removing these items, please retain the packaging.

Install the *DAC* in a well ventilated location away from sources of high temperature, dust or humidity. Never stand the *DAC* under another unit or on any surface likely to hamper its cooling or ventilation.

**IMPORTANT NOTE:-** To avoid damage to your system, always ensure that mains power is disconnected from all system components until installation is complete.

## Model Differences and Upgrades

There are two model versions in the *DAC X+* series –

- The *DAC X+* upsampling audio D/A converter. The *DAC X+* features dual mono DACs and a balanced audio design throughout the analogue domain. The *DAC X+* is a high-end upgrade for a CD transport or other digital audio sources, connecting between the digital outputs of the sources and a preamplifier.
- The *DAC XP+* shares digital technology with the *DAC X+*, adding a fully balanced preamplifier stage with additional analogue audio inputs. The *DAC XP+* can drive a power amplifier directly and replaces a conventional analogue pre-amplifier in a high-end audio system.

This handbook includes instructions for the connection and operation of both the *DAC X+* and *DAC XP+*. Refer to the index to find instructions for the model you own.

In sections that are common to both models, model differences are shown in the text where necessary.

A factory upgrade is available for the *DAC X+* to full *DAC XP+* specification, adding the balanced preamplifier stage.

## Index

Important safety instructions .....	DAC X+ & DAC XP+ .....	1
Introduction .....	DAC X+ & DAC XP+ .....	2
Installation .....	DAC X+ .....	3
Setting up .....	DAC X+ .....	4
Operation .....	DAC X+ .....	5
Installation .....	DAC XP+ .....	6
Setting up .....	DAC XP+ .....	8
Operation .....	DAC XP+ .....	9
Remote control .....	DAC XP+ .....	10
Troubleshooting .....	DAC X+ & DAC XP+ .....	12
Warranty .....	DAC X+ & DAC XP+ .....	12
Specifications .....	DAC X+ & DAC XP+ .....	13

## INSTALLATION (*DAC X+*)

Key to the rear panel drawing (*Fig. 1*)

- |                            |                      |
|----------------------------|----------------------|
| 1. Dual balanced outputs   | 9. Input 5 Digital   |
| 2. Fixed level DAC outputs | 10. Input 6 Digital  |
| 3. MC-BUS connections      | 11. PSX-R connection |
| 4. Optical digital output  | 12. AC mains inlet   |
| 5. Input 1 Optical         |                      |
| 6. Input 2 Optical         |                      |
| 7. Input 3 Digital         |                      |
| 8. Input 4 Digital         |                      |

NOTE: When connecting inputs to the *DAC X+*, ensure that only digital audio sources are connected to 'Digital' inputs.

### Connecting Digital Audio Sources

The digital audio inputs of the *DAC X+* are compatible with a number of different digital audio sources. These include-

- Digital Audio output from a CD player
- DVD players (for replay of 2 channel PCM programs only)
- Digital tape/disc recorders
- Digital Radio
- Digital Satellite receivers (for replay of 2 channel PCM programs only)

Using a suitable Toslink optical or Digital phono interconnect, connect each digital audio source to one of the inputs 1-6. Make a note of the input number used for each source as the inputs of the *DAC X+* can be re-named at the set-up stage.

### Connecting the *DAC X+* to an amplifier

The *DAC X+* requires an external amplifier or preamplifier to provide input selection and volume control functions for the system, and to drive the speakers. Two output options are available from the *DAC X+* via either standard RCA phono outputs, or via balanced audio connections.

CAUTION:- Do not connect power amplifiers to the Fixed output.

#### Connecting to amplifiers with phono inputs

With suitable phono interconnects, connect from the Fixed Out terminals ② to a suitable amplifier line input. All line level inputs, such as CD, TU, AU, AV are suitable. We recommend selection of an input that corresponds to the primary source connected to the *DAC X+*. If the primary source is a CD player, the CD input is recommended, if the primary source is a DVD player, the AV input is recommended etc. For Cyrus amplifiers with optional MC-BUS connection, see also the section 'MC-BUS connections'.

#### Connecting to amplifiers with balanced inputs

If the amplifier is equipped with balanced inputs, the balanced outputs of the *DAC X+* may be used. With suitable balanced interconnects fitted with XLR connectors, connect from the Balanced Output terminals ① of the *DAC X+* to the input of the amplifier. Dual balanced outputs are provided for connection to a second amplifier or recording device with balanced input.

### Connecting to the Digital Output

An optical Digital Output ④ is provided for the connection of another digital device to the *DAC X+*. This may include such devices as a multi-channel surround decoder or a digital tape/disc recorder. The currently selected digital input signal will be routed to this output.

### External Regulated Power Supply - *PSX-R*

The *PSX-R* is a unique DC power supply that will upgrade the sonic performance of your *DAC X+* and other *Cyrus* products. When a *DAC X+* / *PSX-R* combination is installed, the analogue section of the DAC stage is powered from this clean, stable power source while other requirements are supplied internally. This ensures complete isolation of the sensitive analogue sections reducing AC mains-borne noise and power supply ripple.

To connect the *PSX-R* to the *DAC X+*, plug the connector on the umbilical cord of the *PSX-R* into the Multi-Pole socket on the rear of the *DAC X+* ⑥. You will need a mains supply for both units.

NOTE: Connection of a *PSX-R* is detected automatically, so no internal adjustments are required.

## MC-BUS Connections

### MC-BUS operation

Connecting the MC-BUS sockets ③ of the *DAC X+* to those of other *Cyrus* products is an option that provides unified system power control. With MC-BUS connections established the power function of all connected *Cyrus* components may be controlled from the system amplifier or its remote control.

All connected components will also set to Standby when the amplifier is set to Standby.

### MC-BUS connection

An MC-BUS loop is established by connecting single phono cables from the MC-BUS output of one unit to the MC-BUS input of another. Complete the loop by returning the MC-BUS output of the final component to the MC-BUS input of the first. The drawing in Fig 3 shows an example of MC-BUS wiring for a *Cyrus DAC X+* with a CD player, tuner and amplifier.

### MC-BUS configuration

Within a *Cyrus* system, the *DAC X+* may be connected to either the CD, TU, AU or AV input, as selected by the user to best match their system components. To ensure that the *DAC X+* will power on when the correct input is selected, the MC-BUS response may be configured accordingly.

The factory response enables the *DAC X+* to switch on when the CD input is selected from the amplifier. To change the response, refer to the paragraph 'DAC X+ Connected to' in the section 'Setting up the *DAC X+*'.

## SETTING UP THE *DAC X+*

There are many configuration options available in the setup menu to customise the *DAC X+* to best match each individual system.

The setup sequence is activated by pressing the front panel setup button . Each press of the setup button will step through each available setup option until 'Storing settings' is shown on the display. When each setup screen is displayed, changes may be made to the settings by moving the rotary knob.

Settings will be stored automatically after 5 seconds of inactivity. The setup menu options are shown here –

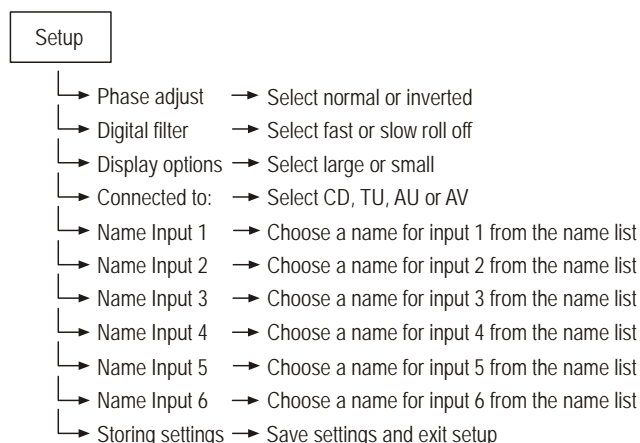

Some examples of the setup display screens are shown in Fig 4.

### Phase adjust (Fig 4a)

This menu option sets the audio phase for the DAC. The factory setting is normal. Some listeners may prefer the inverted setting with their systems or for when playing particular recordings.

### Digital Filter Response (Fig 4b)

This menu option gives two settings for the digital filtering of the DAC stage. Choose your preference of Fast or Slow roll-off by auditioning some of your favourite tracks with each setting.

### DACX Connected to: (Fig 4c)

This option may be used to change the remote control and MC-BUS response of the *DAC X+*. From the factory, the *DAC X+* will power on in response to a CD select command from a *Cyrus* remote control or from a CD select signal sent via MC-BUS, so if the *DAC X+* is connected to the CD input of the amplifier, no change will be required to this setting. If, however, the *DAC X+* is connected to the TU, AU or AV inputs of the amplifier, the appropriate remote and MC-BUS responses may be selected through this menu option to ensure power-on compatibility with the amplifier.

### Input display (Fig 4d)

There are two modes of display operation. The small setting will show a two-line display with the selected input in the display centre and the current sample rate/lock status at the bottom. The large setting will show a single line display with a larger input legend.

### Input names (Fig 4e)

When the *DAC X+* leaves the factory, the input names are set to correspond to the rear panel connections, for example Input 1 will display as Input 1.

The name of *any* input may be changed to a choice from the following list-

- No source (off)
- LaserDisc, DVD, DVD 2, DVD-A, CD, CD 2
- Linkserver, Linkport
- Jukebox, Phono
- Tuner, DAB, TV, AV, Cyrus AV, Satellite, Satellite 2, Cable
- Video, VCR, VCR 2, Tape, MiniDisc, DAT
- PC, Games, Keyboard, Aux, AV Direct, Stream X

To change the names of the inputs, we recommend making a list of each input number with your preferred name from the choices above before setting the names.

No source is a special function name, used to name inputs that have no source connected to them. These input numbers will not then appear in the input selector sequence.

## RESTORING FACTORY SETTINGS

---

You can also restore all configuration options to the initial default settings that were applied at the factory.

NOTE: This operation is not reversible.

To restore factory settings, disconnect mains power from the unit. Now re-connect mains power while holding down the Standby key.

## OPERATION (*DAC X+*)

---

Key to the front panel drawing (Fig.2a):

- |                   |                 |
|-------------------|-----------------|
| 1. Standby key    | 9. Input select |
| 2. Standby light  |                 |
| 4. Display window |                 |
| 5. Setup adjust   |                 |
| 6. Setup select   |                 |

### Switching On

---

The mains power to the *DAC X+* should normally be left on unless left unattended for a long period when the mains power at the wall socket should be switched off or the product disconnected from the AC supply.

When power is applied, the STANDBY key ① is used for power control. The Standby light ② shows red when the *DAC X+* is in Standby and green when operational.

### Selecting an input

---

Inputs may be selected from the front panel INPUT SELECT buttons ③. As a new input is selected the input name/number are displayed briefly. The main display indication for input can be selected from the two options available from the setup menu.

The factory default 'small input' display option will also identify the sample rate of the selected source and indicate 'Invalid Audio Format' for program material which the *DAC X+* will not decode (such as multi-channel digital sound from DVD players or satellite receivers).

### Remote control operation

---

#### *Cyrus* system remote controls

For convenience of operation, the *DAC X+* will respond to CD system select commands from a *Cyrus* amplifier or system remote control, switching on each time the CD system is selected and switching off with power off commands. If the *DAC X+* is connected to a different input (TU, AUX or AV) the remote response may be changed through the set-up menu to match the connected input. Refer to the paragraph 'DAC X+ connected to:' in the 'Setting up the *DAC X+*' section to change the response.

## INSTALLATION (*DAC XP+*)

Key to the rear panel drawing (*Fig. 1*)

- |                                 |                         |
|---------------------------------|-------------------------|
| 1. Dual balanced preamp outputs | 9. Input 5 Digital      |
| 2. Fixed level DAC outputs      | 10. Input 6 Digital     |
| 3. MC-BUS connections           | 11. PSX-R connection    |
| 4. Optical digital output       | 12. AC mains inlet      |
| 5. Input 1 Optical              | 13. Input 7 Analogue    |
| 6. Input 2 Optical              | 14. Input 8 Analogue    |
| 7. Input 3 Digital              | 15. Dual preamp outputs |
| 8. Input 4 Digital              |                         |

NOTE: When connecting inputs to the *DAC XP+*, ensure that only digital audio sources are connected to 'Digital' inputs.

### Connecting Digital Audio Sources

The digital audio inputs of the *DAC XP+* are compatible with a number of different digital audio sources. These include-

- Digital Audio output from a CD player
- DVD players (for replay of 2 channel PCM programs only)
- Digital tape/disc recorders
- Digital Radio
- Digital Satellite receivers (for replay of 2 channel PCM programs only)

Using a suitable Toslink optical or Digital phono interconnect, connect each digital audio source to one of the inputs 1-6. Make a note of the input number used for each source as the inputs of the *DAC XP+* can be re-named at the set-up stage.

### Connecting Analogue Audio Sources

Analogue Inputs 7-8 are available for the connection of stereo analogue audio sources to the *DAC XP+*. Inputs 7-8 are intended for use with analogue program sources which include-

- Analogue output from CD/DVD Players
- Televisions
- Analogue Satellite Receivers
- FM Radio tuners
- Analogue VCRs/Tape recorders
- Surround decoders

### Connecting Power amplifiers

External power amplifiers are necessary to drive the system speakers. Both stereo and high power monoblock *Cyrus* power amplifiers are available to partner the *DAC XP+* and a choice of RCA phono or balanced outputs is provided.

NOTE:- Take care to connect each of the *DAC XP+* output channels to the correct power amplifier and loudspeaker.

#### Connecting to power amplifiers with phono inputs

With suitable phono interconnects, connect from the Pre Out terminals ⑨ to the power amplifier inputs. The system loudspeakers may then be connected to each power amplifier. Dual outputs are provided to enable the connection of two amplifiers for bi-amping.

#### Connecting to power amplifiers with balanced inputs

With suitable Balanced interconnects, connect from the Balanced Output terminals ⑩ to the power amplifier inputs. The system loudspeakers may then be connected to each power amplifier. Dual outputs are provided to enable the connection of two amplifiers for bi-amping.

#### Fixed output

The Fixed output is connected directly to the internal DAC stage of the *DAC XP+* and bypasses the internal preamplifier and volume control. It may be used to feed the DAC stage output to an external system preamplifier, or for high quality tape recording from digital sources.

NOTE:- Analogue inputs 7 and 8 are not routed to the Fixed output.

CAUTION:- Do not connect power amplifiers to the Fixed output.

### Connecting a *Cyrus* Surround Sound decoder

In a *Cyrus* multi-channel surround sound system the surround decoder may be connected through the *DAC XP+* to share the same front channel power amplifiers.

In this case, connect a stereo phono interconnect from the front channel outputs of the surround decoder to the Input 7 sockets ⑪ of the *DAC XP+*. For this system to function correctly both the *DAC XP+* and the *Cyrus surround decoder* must be included in an MC-BUS connection loop and the 'Cyrus AV' input name must be set for Input 7 (see 'MC-BUS' section and 'Input names' in the 'Setup menu' section).

When set up in this way, the *DAC XP+* will automatically check for the presence of the decoder when the 'Cyrus AV' input is selected, then lock the *DAC XP+* volume setting to an appropriate level.

### Connecting a Surround Sound decoder (other brand)

If your system includes a multi-channel surround sound decoder (but not a *Cyrus* model), it may be connected through your DAC to drive the front channel speakers.

In this case, connect a stereo phono interconnect from the front channel outputs of the surround decoder to one of the Analogue Inputs of the DAC. For this system to function correctly, the 'AV Direct' input name must be set for the input used (see 'Input names' in the 'Setup menu' section).

When set up in this way, the DAC will automatically lock its volume setting to a fixed level to match the output of the surround decoder.

CAUTION: The 'AV Direct' input name should only be used for surround decoders that include a volume control, as the volume control of your DAC will be fixed at a very high level.

### Connecting to the Digital Output

An optical Digital Output ⑫ is provided for the connection of another digital device to the *DAC XP+*. This may include such devices as a multi-channel surround decoder or a digital tape/disc recorder. The currently selected digital input signal will be routed to this output.



## External Regulated Power Supply - *PSX-R*

The *PSX-R* is a unique DC power supply which will upgrade the sonic performance of your *DAC XP+* and other *Cyrus* products. When a *DAC XP+* / *PSX-R* combination is installed, the analogue section of the DAC stage is powered from this clean, stable power source while other requirements are supplied internally. This ensures complete isolation of the sensitive analogue sections reducing AC mains-borne noise and power supply ripple.

To connect the *PSX-R* to the *DAC XP+*, plug the connector on the umbilical cord of the *PSX-R* into the Multi-Pole socket on the rear of the *DAC XP+* ⑥. You will need a mains supply for both units.

NOTE: Connection of a *PSX-R* is detected automatically, so no internal adjustments are required.

## MC-BUS Connections

### MC-BUS operation

Connecting the MC-BUS sockets ③ of the *DAC XP+* in an MC-BUS system provides unified system power control. With MC-BUS connections established the power function of all connected *Cyrus* components may be controlled from the *DAC XP+* front panel or remote control. Refer to the following table for *Cyrus* components that will be activated by the *DAC XP+* when the inputs have been named as listed -

Input name	Power on response
CD	CD players, power amplifiers
TUNER	Tuners, power amplifiers
AV	DVD players, power amplifiers
CYRUS AV	DVD players, surround decoders, power amplifiers
DVD	DVD players, power amplifiers

Follow the instructions in section 'Setting up the *DAC XP+*' to set the listed input names.

All connected components will also set to Standby when the *DAC XP+* is set to Standby.

### MC-BUS connection

An MC-BUS loop is established by connecting single phono cables from the MC-BUS output of one unit to the MC-BUS input of another. Complete the loop by returning the MC-BUS output of the final component to the MC-BUS input of the first. The drawing in Fig 3 shows an example of MC-BUS wiring for a *Cyrus DAC XP+* with a CD player, tuner and power amplifier.

**SETTING UP THE DAC XP+**

There are many configuration options available in the setup menu to customise the DAC XP+ to best match each individual system.

The setup sequence is activated by pressing the front panel set up button . Repeated pressing of the setup button will step through each available setup option until 'Storing settings' is shown on the display. When each setup screen is displayed, changes may be made to the settings by rotating the front panel volume knob.

The setup sequence will cancel after 5 seconds of inactivity.

The setup menu options are shown here –

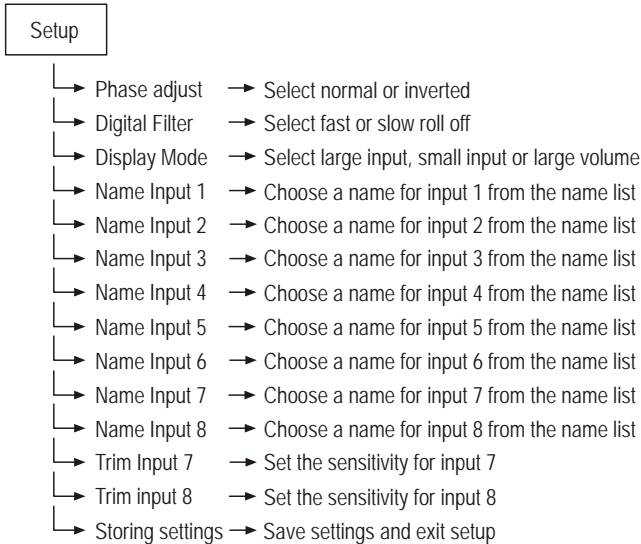

Some examples of the setup display screens are shown in Fig 4.

**Phase adjust (Fig 4a)**

This menu option sets the audio phase for the DAC. The factory setting is normal. Some listeners may prefer the inverted setting with their systems or for when playing particular recordings.

**Filter adjust (Fig 4b)**

This menu option gives two settings for the digital filtering of the DAC stage. Choose your preference of Fast or Slow roll-off by auditioning some of your favourite tracks with each setting.

**Display mode (Fig 4c)**

There are three modes of display operation.

The 'small input' setting will show a three line display with the volume reading at the top of the display, the selected input in the display centre and the current sample rate/lock status at the bottom.

The 'large input' setting will show a two line display with the volume reading at the top and a larger input legend below.

The 'large volume' setting will display large volume characters at the bottom of the screen with the bargraph above.

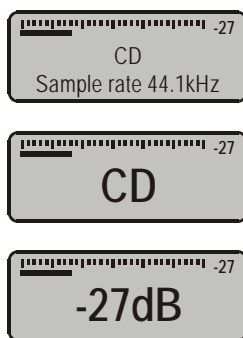

**Input names (Fig 4d)**

When the DAC XP+ leaves the factory, the input names are set to correspond to the rear panel connections, for example Input 1 will display as Input 1.

The name of any input may be changed to a choice from the following list-

- No source (off)\*
- LaserDisc, DVD, DVD 2, DVD-A, CD, CD 2
- Linkserver, Linkport
- Jukebox, Phono
- Tuner, DAB, TV, AV, Cyrus AV\*, Satellite, Satellite 2, Cable
- Video, VCR, VCR 2, Tape, MiniDisc, DAT
- PC, Games, Keyboard, Aux, AV Direct\*, Stream X.

To change the names of the inputs, we recommend making a list of each input number with your preferred name from the choices above before setting the names.

There are three special function input names marked \*.

'No source' is used to name inputs which have no source connected to them. These input numbers will not then appear in the input selector sequence.

'Cyrus AV' is reserved for the connection of Cyrus surround sound decoders. When a Cyrus surround decoder is connected to an analogue input named 'Cyrus AV' the DAC XP+ will check the system for the presence of a Cyrus surround decoder and, if found, lock out its volume control at a precise setting. Normal volume operation will be restored when any other input is selected.

'AV Direct' is reserved for the connection of non-Cyrus surround decoders to an analogue input. This input name must only be used for this purpose as the volume level will lock to a very high setting (-6dB) when AV Direct is selected.

**Input trims (Fig 4e)**

It is possible to adjust the sensitivity of analogue inputs 7 and 8 by selecting the appropriate trim option from the menu. This enables the volume level when playing low or high output source components such as tape decks or tuners to be equalised with the digital system sources.



**RESTORING FACTORY SETTINGS**

You can also restore all configuration options to the initial default settings that were applied at the factory.

NOTE: This operation is not reversible.

To restore factory settings, disconnect mains power from the unit. Now re-connect mains power while holding down the Standby key.

## OPERATION (*DAC XP+*)

---

Key to the front panel drawing (Fig.2):

1. Standby key	6. Setup select
2. Standby light	7. Channel balance select
3. Remote eye	8. Mute
4. Display window	9. Input select
5. Level control and setup adjust	

### Switching On

---

The mains power to the *DAC XP+* should normally be left on unless left unattended for a long period when the mains power at the wall socket should be switched off or the product disconnected from the AC supply.

When power is applied, the STANDBY key ① is used for power control. The Standby light ② shows red when the *DAC XP+* is in Standby and green when operational.

### Selecting an input

---

Inputs may be selected from the front panel INPUT SELECT buttons ④ or with the remote control INPUT SELECT keys. As a new input is selected the input name/number are displayed briefly. The main display indication for input/volume can be selected from the three options in the setup menu.

The factory default 'small input' display option will also identify the sample rate of the selected source and indicate 'Invalid Audio Format' for program material which the *DAC XP+* will not decode (such as multi-channel digital sound from DVD players or satellite receivers).

### Volume and Balance

---

The level control ⑤ of the *DAC XP+* performs the dual functions of volume and balance.

**Volume:** In normal mode the level control sets the volume in 1dB steps. A bargraph and a numeric scale at the top of the display window show the current volume setting. The last used volume setting is stored when the unit is set to standby.

If the volume is left at an abnormally high volume level before entering standby, the level will be reduced automatically to a safe level of -15dB for next use.

**Balance:** Press the balance control key ⑦ to change the mode of the front panel rotary control ⑤ to set Left/Right Balance. The volume display will also change to show a graphic and numeric display of the balance setting.

### Mute

---

Pressing the MUTE Key ⑧ will mute the volume to minimum level without disturbing the existing volume setting. When muted the display will show that volume is muted. Move the volume knob up or press the Mute key to fade back up to the original volume setting.

### Programmable Input Sensitivity

---

You may find an audible difference in level when switching from digital inputs to one of the two analogue inputs due to the differing outputs of your source components. The unique calibration memory of the *DAC XP+* can be programmed to match the sensitivity of these inputs with reference to the digital inputs. Input sensitivity settings are made through the setup menu. Refer to the section 'Setting up the *DAC XP+*' for more details.

## OPERATION WITH THE AVR57.2 REMOTE CONTROL (DAC XP+)

The *DAC XP+* is supplied with the *Cyrus AVR57.2* remote control which will control *Cyrus* CD players, DVD players, tuners and surround sound decoders in addition to the *DAC XP+*.

### System select keys

Commands may be sent to different *Cyrus* system components by selecting the appropriate system select key on the handset. These keys are marked CD, TU/DAB, AV, AV-S and AV SETUP. The CD, TU/DAB, AV, AV-S keys will flash when any command is transmitted to show which type of product is under control. Commands to a Surround Decoder from the AV SETUP system will flash the AV-S indicator.

To identify which type of product is under control, the CD, TU/DAB, AV, AV-S keys flash when any command is transmitted. Commands to a surround decoder from the AV SETUP system will flash the AV-S indicator.

The remote control will send commands to most products within the *Cyrus* range and is compatible for use within two types of *Cyrus* system -

- Stereo audio systems including a *DAC XP+* as preamplifier.
- Multi-channel AV systems including both a *DAC XP+* digital preamplifier and a *Cyrus* surround decoder.

Refer to the following section as appropriate to the configuration of your system.

### Controlling a stereo system

A stereo system may include the *DAC XP+*, a CD player, tuner or DVD player. The following commands may be sent -

- Pressing CD will send commands to a *Cyrus* CD player. This key will also switch on the *DAC XP+* and select an input named CD.
- Pressing TU/DAB will send commands to DAB radios or FM Tuners. This key will also switch on a DAB radio or FM Tuner and select an input named Tuner. To change between DAB or FM operation, hold down the TU/DAB key for 3 seconds until the light changes colour. The key will light green when set for DAB commands or red when set for FM tuner commands. NOTE:- The FM band of a DAB radio is not selected in this way, the BAND key is used for this purpose.
- Pressing AV will send commands to a DVD player. This key will also switch on a DVD player and select an input named AV, Cyrus AV or AV Direct on the *DAC XP+*.

The *DAC XP+* will respond to the volume, balance, mute and input keys when any of the above systems are selected. In the above examples, direct access input select will only function when these inputs have been named using the *DAC XP+* setup menu.

NOTE - The AV-S and AV SETUP keys are not used to control this system.

### Controlling a multi-channel AV system that includes both a DAC XP+ and a Cyrus surround decoder

This system will include both a *DAC XP+* and a *Cyrus* surround decoder with a CD player, tuner or DVD player. In such a system it is expected that -

- Stereo sources will be connected directly to the inputs of the *DAC XP+*.
- The DVD player will connect directly to the surround decoder and the front channel outputs of the surround decoder will connect to the AV input of the *DAC XP+*.
- An MC-BUS connection loop will also be set up between at least the *DAC XP+* and the surround decoder.

The following commands may be sent -

- Press CD to send commands to CD players. This key will also switch on a CD player and select an input named CD on the *DAC XP+*. Volume, balance, input and mute commands will also be sent to the *DAC XP+*.
- Pressing TU/DAB will send commands to DAB radios or FM Tuners. This key will also switch on a DAB radio or FM Tuner and select the TU input of an amplifier. To change between DAB or FM operation, hold down the TU/DAB key for 3 seconds until the light changes colour. The key will light green when set for DAB commands or red when set for FM tuner commands. NOTE:- The FM band of a DAB radio is not selected in this way, the BAND key is used for this purpose.

- Press AV-S to send commands to a DVD player. This key will also switch on a DVD player and select the surround decoder via the 'Cyrus AV' input of the *DAC XP+*. Volume, balance, input and mute commands will be sent to the surround decoder.
- Press AV SETUP to activate the blue keys and those with additional blue legends to send setup commands to the surround decoder, such as speaker balance settings, mode settings and input naming.

In the above examples, input select will only function when these inputs have been named using the *DAC XP+* setup menu.

NOTE - The AV key is not used to control this system.

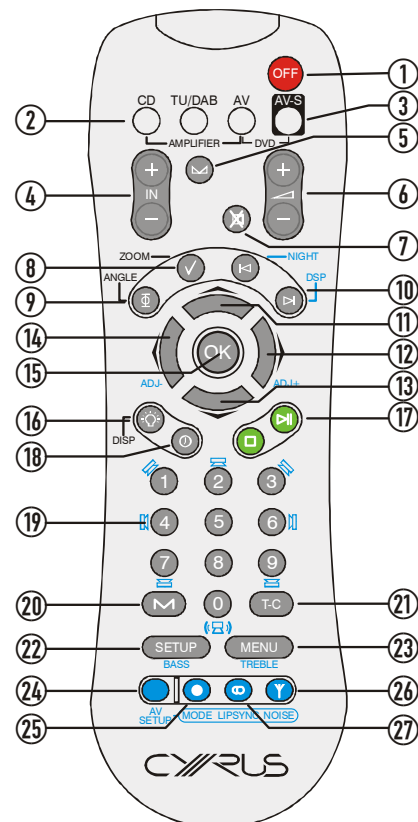

DAC XP+, CD, DAB and FM tuner commands

	CD MODE	DAB MODE	TU MODE (FM)
1	Power off all systems		
2	CD, DAB, TU or AV COMMAND MODE SELECT DAC XP+, CD, DAB, FM tuner, DVD power on DAC XP+ input select		
3	AV SURROUND COMMAND MODE SELECT – see table below		
4	DAC XP+ input select		
5	DAC XP+ balance select		
6	DAC XP+ volume control		
7	DAC XP+ mute		
8	-	Select station on display	-
9	Audio phase invert	-	-
10	Next/previous track	Display next/previous station	Next/previous preset
11	Next track	Cursor keys for navigating the on-screen menu options	Next preset
12	Search forward		Scan up
13	Previous track		Previous preset
14	Search reverse		Scan down
15	-	OK key to select menu options	-
16	Display off	Display mode	Display off
17	Play/pause/stop*	Play/pause for replay from memory card	-
18	Display mode	Timer record mode	-
19	Numeric keypad	Numeric keypad	Preset select
20	Memory store	Preset information	Preset store
21	-	-	-
22	-	-	-
23	-	Menu select	-
24	AV SETUP MODE SELECT – see table below		
25	-	Record to memory card	-
26	-	DAB/FM/Memory card band select	-
27	-	Mono/stereo when playing FM	Stereo/mono

\*early Cyrus CD players will respond to Play/Stop only

DAC XP+, DVD and AV -Surround commands

	AV (DVD & amp) MODE	AV-S (DVD & decoder) MODE	AV-SETUP MODE
1	Power off all systems		
2	CD, DAB, TU or AV COMMAND MODE SELECT DAC XP+, CD, DAB, FM tuner, DVD power on DAC XP+ input select		
3	AV-S COMMAND MODE SELECT DVD and Surround decoder power on		
4	DAC XP+ input select +/-	Surround decoder input select +/-	
5	DAC XP+ balance mode	-	
6	DAC XP+ volume control	Surround decoder volume control	
7	DAC XP+ mute	Surround decoder mute	
8	DVD Quick access zoom		-
9	DVD Quick access angle		-
10	DVD Next/previous chapter/title		Decoder Night & DSP functions
11	Cursor keys for navigating the DVD on-screen menu options		-
12			Adj +
13			-
14			Adj -
15	OK key to select DVD menu options		-
16	DVD On-screen display		-
17	DVD transport functions		-
18	-		-
19	DVD Chapter/title direct access		Speaker select keys
20	DVD Program store		-
21	DVD Title or Chapter mode		-
22	DVD Player setup		Bass control select
23	DVD Disc menu		Treble control select
24	AV SETUP MODE SELECT Surround decoder power on		
25	-	Mode select	
26	-	Lipsync adjust	
27	-	Decoder noise mode	

**TROUBLESHOOTING GUIDE**

If your *Cyrus DAC* is not operating properly, disconnect the power and carefully check all connections and the set-up procedure using the notes in this handbook. If problems persist, the checklists below may help.

If you are in any doubt, consult your dealer.

<b>No sound from any speaker with any source</b>	
Amplifiers not switched on.	Switch on all of the system amplifiers.
Outputs to amplifiers not correctly connected.	Switch off the power to the audio system and check that connections have been correctly made from the <i>DAC</i> to the system amplifiers and speakers.
<b>No sound from one source</b>	
Incorrect source selected.	Check source selection.
Input named incorrectly.	Check that the input is correctly named.
Pause may have been set.	Check the source.
Incompatible audio format.	Check the audio format of the disc/tape to ensure it is compatible with the <i>DAC</i> .
Input not correctly connected.	Switch off the power to the audio system and check that connections have been correctly made from the source to the <i>DAC</i> .
<b>Loud noises from the speakers with certain sources or discs</b>	
Incompatible audio format.	Check the audio format of the disc/tape to ensure it is compatible with the <i>DAC</i> .
<b>No sound from one loudspeaker</b>	
Balance control at extreme limit.	Centralise Balance control.
Does your speaker have fuses?	Check speaker, replace fuses.
Power amplifier faulty ( <i>DAC XP+</i> only).	The power amplifier(s) can be tested by exchanging left and right output channels from the <i>DAC XP+</i> . Switch off the power to the audio system before making any changes to the connections.
<b>Remote control not operating</b>	
Remote control not operating (lights on remote are weak or not flashing when commands are sent).	Check batteries.
Remote control not operating (lights on remote are flashing correctly).	Ensure that the correct system has been selected on the remote for the system components you are operating.

If a fault condition still remains, return the *DAC* (together with the *PSX-R* if you are using one) to your *Cyrus* appointed dealer or an authorised Service Centre.

**WARRANTY**

The warranty should be registered on-line within 8 days of purchase. No Dealer or Distributor may vary the terms of this warranty, which is personal to the original Purchaser and is not transferable.

Please retain the sales receipt as proof of purchase.

Warranty claims must wherever possible be made through the retailer from whom the equipment was purchased.

This warranty excludes:

- Damage caused through neglect, accident, misuse, wear and tear, or through incorrect installation, adjustment or repair by unauthorised personnel. Any unauthorised servicing will result in loss of warranty.
- Liability for damage or loss occurring in transit to or from the purchaser.
- Consequential damage, loss or injury, arising from or in conjunction with this equipment.

Equipment for attention under warranty should be consigned return carriage paid. If returned equipment is found to comply with the published specification, *CYRUS* reserves the right to raise a charge.

The above conditions do not affect your statutory rights as a consumer.

**WEEE**

This logo means that this product is not to be disposed of with your household waste. This product should be handed over to a designated collection point to be recycled. Your cooperation in the correct disposal of this product will contribute to the effective usage of natural resources. For more information on collection points, contact your disposal service or City Hall.



**Specifications (DAC X+)****Power Supply**

Voltage: .....	As plate on rear of unit
Power consumption (Standby) .....	12W
Power consumption (Operational).....	14W
EMC & Safety Compliance.....	CE

**Enclosure**

Dimensions (WxHxD) .....	215 x 75 x 365mm
Weight .....	3.8Kg
Material.....	Die cast chassis

**Audio Performance****Inputs**

Input voltage.....	500mV pk-pk
Input Impedance .....	75Ω
S/N ratio, (PCM in, 0dBFS).....	115dBA
THD+N, (PCM in, 0dBFS).....	0.002%

**Outputs**

Output voltage (dig. in, vol max) .....	Fixed out..... 2.3V
	Balanced out ..... 4.6V
Output Impedance.....	Fixed out..... 47Ω
	Balanced out ..... 47Ω

**Specifications (DAC XP+)****Power Supply**

Voltage: .....	As plate on rear of unit
Power consumption (Standby) .....	20W
Power consumption (Operational).....	22W
EMC & Safety Compliance.....	CE

**Enclosure**

Dimensions (WxHxD) .....	215 x 75 x 365mm
Weight .....	6.5Kg
Material.....	Die cast chassis

**Audio Performance****Analogue Inputs**

Input Sensitivity .....	200mV
Input Impedance .....	47kΩ
Input Overload level (1KHz, 0.01%THD) .....	4.3V
S/N ratio, (500mV i/p, max.vol.) .....	100dBA
THD+N, (500mV i/p, max.vol.) .....	0.002%
Channel separation (1kHz).....	85dB

**Digital Inputs**

Input voltage .....	500mV pk-pk
Input Impedance .....	75Ω
S/N ratio, (PCM in, 0dBFS) .....	115dBA
THD+N, (PCM in, 0dBFS) .....	0.002%

**Analogue Outputs**

Output voltage (dig. in, vol max).....	Fixed out..... 2.3V
	Pre out..... 4.4V
	Balanced out..... 8.4V
Output Impedance.....	300Ω



Cyrus Audio Ltd., Ermine Business Park, Huntingdon, PE29 6XY, U.K.